

ICT



Coin Changer
CC6100
series

Quick Start Guide

International Currency Technologies Corp.

Use of Materials Limitations

International Currency Technologies Corporation (ICT) all rights reserved.

All materials contained are the copyrighted property of ICT.

All trademarks, service marks, and trade names are proprietary to ICT.

ICT reserves the right at all times to disclose or to modify any information as ICT deems necessary to satisfy any applicable law, regulation, legal process or governmental request, or to edit, refuse to post or to remove any information or materials, in whole or in part, in ICT's sole discretion.

Contents

1. Before use	2
2. Installation	
2-1. Device Mounting Instruction.....	3
2-2. Tube Cassette Refill Instruction.....	4
2-3. Installation Checklist.....	4
2-4. Initialization Checklist.....	6
3. Wiring	
3-1. Wiring for CC6100 JPSTD Model or MDB Model.....	7
3-2. Wiring for CC6100 Executive & MDB Model.....	7
4. LCM Module Description	8
4-1. LCM Main Menu Table.....	8
5. DIP Switch Setting	
5-1. DIP Switch Setting for JPSTD, MDB.....	12
5-2. DIP Switch Setting for EXECUTIVE.....	13
5-3. DIP Switch Setting for CC6100SA.....	14
6. Error Message	15

1. Before use

Dear Valuable customer, thank you for purchasing CC6100. CC6100 features six modular coin tubes to provide the highest level of flexibility in managing payout combinations. Japan Standard Communication Interface (JPSTD), MDB and Executive interface are available, to support multiple applications.

Package Contents :

- CC6100 with one of the following wire harness
 - WEL-RCC23 Power and Data Communication cable for MDB.
 - WEL-RCC24 Power and Data Communication cable for JPSTD.
 - WEL-RCC72 & WEL-RCC54 Power and Data Communication cable for CC6100 Executive & MDB.
- Quick Start Guide

CC6100 Installation instructions can be downloaded at:

www.ictgroup.com.tw

Select "Support" from menu, then select "Manual Download".

2. Installation

Attention!! Prior installation, please remove the coin changer from the carton and inspect for damages.

Attention!! Turn off VMC Power during installation-IMPORTANT!!!

Warning!! Do not plug both MDB and Executive connector to VMC board simultaneously!! It may cause damage of VMC board.

2-1. Device Mounting Instruction

1. Press the green hook at the left side of the coin changer and tilt the upper module.
2. Unplug flat cable to separate upper module from device.
3. Loosen the 3 mounting screws 2 or 3 turns.(do not unscrew these completely)
Lift the coin changer to mount inside the vending machine.
4. Tighten the screws and place the upper module back to the device.
5. Plug flat cable back to upper module then close the upper module till it firmly fixed by green hook.
Plug device power and communication cable to vending machine.

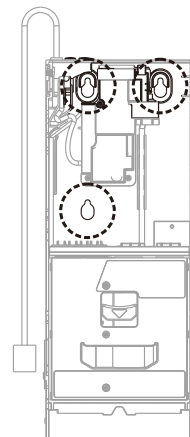
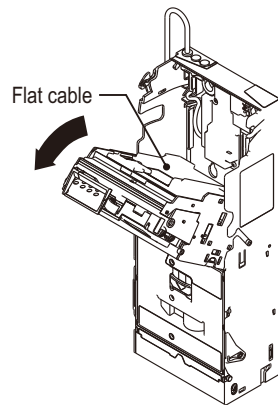

2-2. Tube Cassette Refill Instruction

1. Press the green cassette fixed latch to pull out the cassette at an upwardly slanted angle.
2. Refill coins into tube cassette and ensure that the coins enter the corresponding tubes and flatly placed. Then place the tube cassette back to Changer.

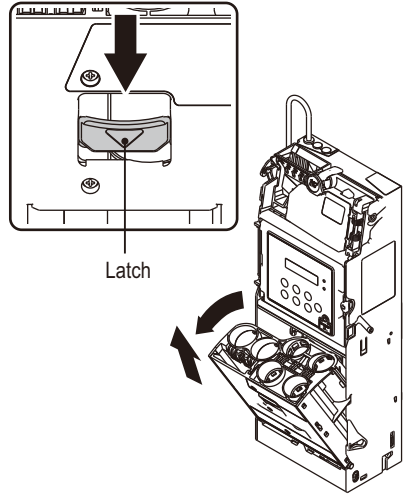

*You may choose coin refill mode to fill coins without open tube cassette.

2-3. Installation Checklist

Check that there is a 3 to 5 mm gap between the coin changer return lever and the vending machine return mechanism.

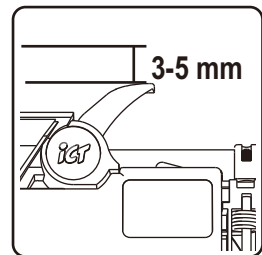

Check that when vending machine return lever has been pressed and released, the reject gate of the coin recognition module can be opened and closed properly.

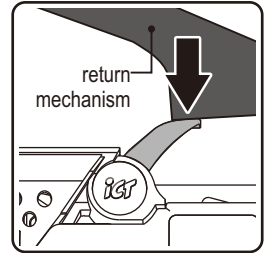

Check that the coin insertion, coin return box, and coin storage box channels of the vending machine line up with the corresponding slots of the coin changer. If the slot has not been lined up, please adjust accordingly.

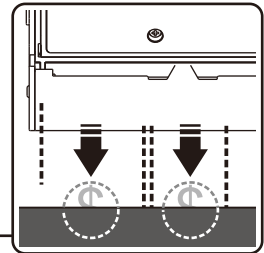
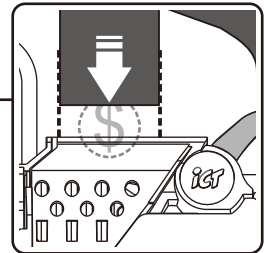
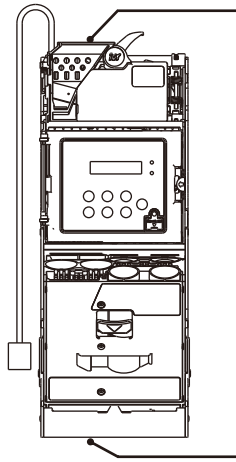

Insert a coin to check whether it can pass through the coin changer successfully. Please ensure that there is no interference around the coin recognition module.

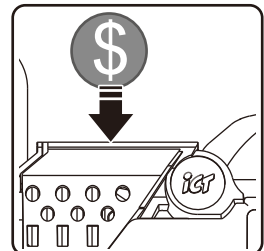

2-4. Initialization Checklist

While vending machine in an energized state, please DO NOT plug/unplug any wires on CC6100.

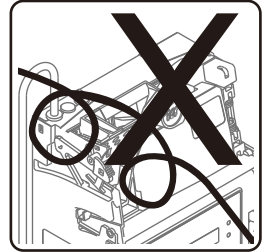

Please ensure that there are no interferences between the connected wires, the coin insert and return device, and the door of the automatic vending machine. After the inspections are complete, then turn on the vending machine power.

Check the amount of coins in each coin tube is above the minimum requirement level. Please refer to sticker on the tube cassette for minimum level information. (The coin changer would not work correctly without enough coins in the coin tubes.)

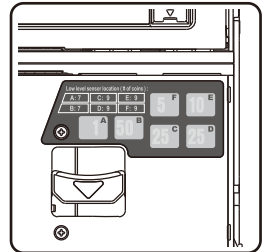

After refill of tube cassette, the coin changer will detect the adequate coin quantity within a few seconds.

Dispense at least 1 coin from each coin tube to ensure that the dispensed coins fall into the coin return box of the vending machine.

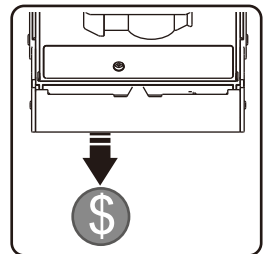

3. Wiring

3-1. Wiring for CC6100 JPSTD Model or MDB Model

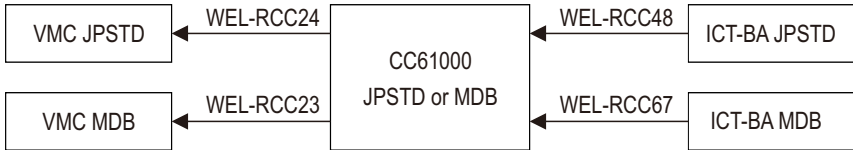

ICT Coin Changer provides the MDB or JPSTD cable only. Please let your sales representative know to your vending machine needs.

3-2. Wiring for CC6100 Executive & MDB Model

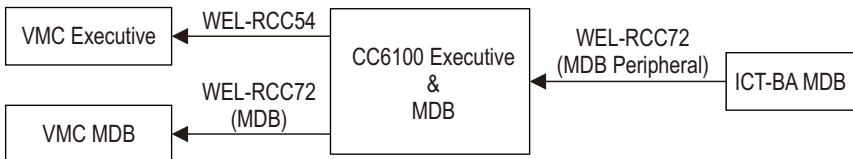

Warning!! Do not plug both MDB and Executive connector to VMC board simultaneously!! It may cause damage of VMC board.

4. LCM Module Description

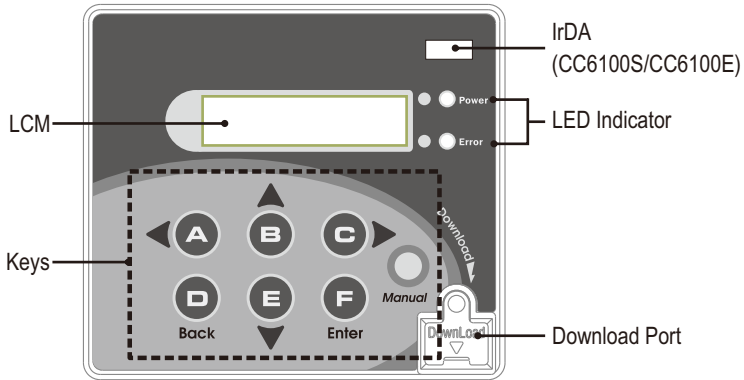

KEY	Function
A	Tube A, move left
B	Tube B, move upward
C	Tube C, move right
D	Tube D, back

KEY	Function
E	Tube E, move downward
F	Tube F, enter
Manual	Enter main menu

4-1. LCM Main Menu Table

Operation functions			
Code	LCM Menu Display	Function Description	
100	Refill Coin	Coin Refill Function by Coin Insertion under Cash Flow Mode.	Accessible without password. Cash Flow Mode only.
101	Total In/Out	Check the Total Coin PayIn and PayOut Value Counter.	Accessible without password
115	Clear Tube Count	Clear Counting Memory of All Coin Tube Inventory.	Accessible without password
129	Language	Set language.	Accessible without password

To access all menu functions requires password verification. Press “D” 3 times under main menu to open password input page. Default Password is **ABCD**. See next page for complete menu functions.

Setting Functions			
Code	LCM Display	Function Description	
102	Reset Records	Clear the Total Coin PayIn and PayOut Value Record.	
103	Accept/ Reject Coin Switch	Set Accept or Reject to Coin Denominations.	
104	Tube Open/ Close Switch	Set Open or Close to Coin Tubes.	
107	Configure Cash Float	Set Cash Float Configuration for Various Coin Denominations.	Cash Flow Mode only
108	Activate Cash Float	Set Cash Float Type for Various Coin Denominations.	Cash Flow Mode only
109	Check Current Cash Float	Check Current Cash Float of Various Coin Denominations.	Cash Flow Mode only
110	Change Mgmt.	Set the Change Return Mode.	
111	Idle Display	Set the Standby LCM Display Mode.	
112	BA Type Setting	Set the BA Interface.	
113	Default Setting	Restore to Default Factory Settings.	
116	Cassette Type	Coin Tube Configuration Mode.	Special Function
117	Error Info	Display Error Message Records.	
118	Bill(s) per Transaction	Set the Bill Acceptance Limitation for the BA.	ICT BA only
119	CashFloat Mode	Set Coin Tube Inventory Counting Mode.	Cash Flow Mode only
120	Set ID	Set Customer & Machine Number.	
121	Coin->CashBox Setting	Set Coin Acceptance to Cash Box Condition.	
122	Expansion Escrow Setting	Set Escrow for NTD 50.	Special Function, only for NTD
123	Sensor Inventory Adjustment	Detect Tube Inventory.	
124	Reserved Coin	Set Reserved Coin Function.	
125	Accessibility options	Set LCM accessibility under door-switch status and password security.	
126	Refill Coin Inventory	Refill Coin Inventory function by inserting coins into tube cassette directly.	

Setting Functions			
Code	LCM Display	Function Description	
127	Residual Credit	Credit should remain on VMC.	
128	Token Learning Mode	Token learning mode.	For MDB & Executive
130	Reject Lever Setting	Set no refund after inserting payment.	For MDB & Executive
131	Acceptance limit For Changer	Set Credit Acceptance Limit.	Only MDB for KRW
132	Maximum for Insert Q'TY	Set limitation of coins in single transaction.	Only MDB for KRW
133	Decimal and Scaling	Set Decimal point and Scaling Factor.	For MDB & Executive
134	Currency Code	Setting Currency Code.	
135	Error Report	Setting Error Report Function.	
136	Payout Method	Setting Payout Method(Level 2).	
137	Refill Option	Setting Refill Option.	
138	Channel sequence	Setting Channel sequence.	
139	IDR credit	Setting Indonesia Credit.	Only for Indonesia
140	EVA-DTS ID data	Setting EVA-DTS ID.	
141	Bill Escrow Return	Setting Bill Escrow Return.	
142	Sorting Module Testing	Setting Tube Test Mode.	
143	Tube Detection(after sale)	Setting Tube Detection Function.	Only for Russia
144	Overpay	Set Overpay.	Only for UAH, USD, EUR
146	Resend Credit	Setting Resend Credit Function.	
147	RC Settings	Setting Recycle Function.	
148	VMC Reset TO VMC	Setting VMC reset Function.	
149	Refill Control(Full Tube)	Setting Refill Control.	
150	Low inventory report(real)	Setting Low inventory report.	Only for SGD, MYR, THB
151	Secure mode for THB coin	Setting Secure mode.	Only for THB
152	Fuji dispensing coin mode	Setting Fuji dispensing coin mode.	Only for THB
153	RFID deduction amount	RFID deduction amount setting mode.	JPSTD-TWD and THB
154	RS232 mode	RS232 mode setting.	

Setting Functions			
Code	LCM Display	Function Description	
156	Set give changes order	TWD set give changes order.	Only for TWD
157	VMC support value	Set up VMC support value.	
158	Set up and write each tube stock of coins	THB set up and write each tube stock of coins.	Only for THB
160	JPY Amount display	JPY Amount display options	Only for JPY
161	NTD 50 special entry condition	NTD 50 special entry condition setting	Only for TWD

Executive Setting Functions			
Code	LCM Display	Function Description	
200	Sell Mode	Set Single Vend or Multi Vend.	Executive only
201	Price Display	Set Price Display on VMC.	Executive only
202	Product Price	Set Product Price Holding by Changer.	Executive only
203	Price Holding	Set Price Holding by Changer or VMC.	Executive only
204	2nd Price for Cashless	Set 2nd price for cashless function on or off.	Executive only
205	Enable Bill Acceptance	Set BA enable with or without e-key.	Executive only
207	Residual Credit	Setup residual credit.	Executive only
208	Acceptance limit For Changer	Set Credit Acceptance Limit.	Executive only
209	Credit limit For Cashless	Set Credit limit for cashless.	Executive only
210	Bill(s) per Transaction	Set BA limitation per transactio.	Executive only
211	Exact Change Notice	Set exact change notice on display.	Executive only
212	Exact Rate	Set Exchange Rate.	Executive only
213	Overpay	Set Overpay.	Executive only

5. DIP Switch Setting

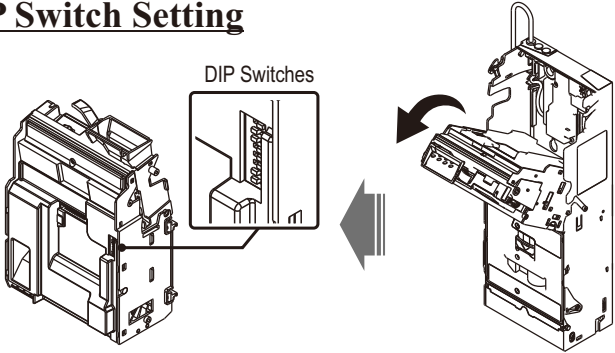

5-1. DIP Switch Setting for JPSTD, MDB

FUNCTION	SW1	SW2	SW3	SW4	SW5	SW6	SW7	SW8
High anti-counterfeiting (1st coin value)	ON							
High acceptance (1st coin value)	OFF							
High anti-counterfeiting (2nd coin value)		ON						
High acceptance (2nd coin value)		OFF						
High anti-counterfeiting (3rd coin value)			ON					
High acceptance (3rd coin value)			OFF					
High anti-counterfeiting (4th coin value)				ON				
High acceptance (4th coin value)				OFF				
Reserved					ON			
Reserved					OFF			
Reserved						ON		
Reserved						OFF		
Calibration Mode							ON	
Reserved							OFF	
Reserved								ON
Reserved								OFF

Note:

- SW3-ON, High anti-counterfeiting: CNY \$1, RUB \$5, TWD \$50
- SW4-ON, High anti-counterfeiting: RUB \$10
- Acceptance rate setting, SW1 to SW4, is limited to some regions or denominations. Please contact your local dealer for further information.

5-2. DIP Switch Setting for EXECUTIVE

FUNCTION	SW1	SW2	SW3	SW4	SW5	SW6	SW7	SW8
High anti-counterfeiting (1st coin value)	ON							
High acceptance (1st coin value)	OFF							
High anti-counterfeiting (2nd coin value)		ON						
High acceptance (2nd coin value)		OFF						
High anti-counterfeiting (3rd coin value)			ON					
High acceptance (3rd coin value)			OFF					
High anti-counterfeiting (4th coin value)				ON				
High acceptance (4th coin value)				OFF				
Reserved (MDB)					ON			
Reserved (Executive)					OFF			
Reserved						ON		
Reserved						OFF		
Calibration Mode							ON	
Reserved							OFF	
Reserved								ON
Reserved								OFF

Note:

- SW3-ON, High anti-counterfeiting: CNY \$1, RUB \$5, TWD \$50
- SW4-ON, High anti-counterfeiting: RUB \$10
- Acceptance rate setting, SW1 to SW4, is limited to some regions or denominations. Please contact your local dealer for further information.

5-3. DIP Switch Setting for CC6100SA

FUNCTION	SW1	SW2	SW3	SW4	SW5	SW6	SW7	SW8
High anti-counterfeiting (1st coin value)	ON							
High acceptance (1st coin value)	OFF							
High anti-counterfeiting (2nd coin value)		ON						
High acceptance (2nd coin value)		OFF						
High anti-counterfeiting (3rd coin value)			ON					
High acceptance (3rd coin value)			OFF					
High anti-counterfeiting (4th coin value)				ON				
High acceptance (4th coin value)				OFF				
Calibration Mode					ON			
Reserved					OFF			
Reserved						ON		
Reserved						OFF		
Reserved							ON	
Reserved							OFF	
Reserved (Turn off the sleep mode)								ON
Reserved (Turn on the sleep mode)								OFF

Note:

- SW3-ON, High anti-counterfeiting: CNY \$1, RUB \$5, TWD \$50
- SW4-ON, High anti-counterfeiting: RUB \$10
- Acceptance rate setting, SW1 to SW4, is limited to some regions or denominations. Please contact your local dealer for further information.

6. Error Message

Code	Cause	LED
E10	LCM Panel Open	5 Red + 2 Red
E11	Checksum Error	Red Light
E12	Signal from the coin base was not received when the power was turned on.	Red Light
E13	Two seconds after activation, the SYSTEM did not wait for the READY signal from the DEVICE and jumped to the exception.	1 Red
	Two seconds after a transaction, the SYSTEM did not wait for the READY signal triggered by the DEVICE.	
E14	Coil 1 is damaged.	3 Red + 1 Red
E15	Coil 2 is damaged.	3 Red + 2 Red
E16	Coil 3 is damaged.	3 Red + 3 Red
E17	Low level LED is damaged.	3 Red + 5 Red
E18	Coin separator sensor problem.	3 Red + 4 Red
E19	The deck is open for over 30 seconds.	5 Red + 1 Red
E20	Both the first and second group motors cannot be positioned.	7 Red
E21	The first motor group cannot be positioned. The first motor group might be damaged, coin or foreign objects might have caused the motor to stuck, coins are stuck in the coin tube, or the semicircle disk has derailed.	None
E22	The second motor group cannot be positioned. The second motor group might be damaged, coin or foreign objects might have caused the motor to stuck, coins are stuck in the coin tube, or the semicircle disk has derailed.	None
E23	Broke away or incorrectly positioned coin tubes.	5 Red
E24	Coins got stuck at the coin separation area or the coin tube opening twice in a row, causing the HI Level Sensor to fail to detect the coin twice in a row.	6 Red + 4 Red
E25	"A" Tube Low Level = empty, HI Level = full at setup.	None
E26	"B" Tube Low Level = empty, HI Level = full at setup.	None
E27	"C" Tube Low Level = empty, HI Level = full at setup.	None
E28	"D" Tube Low Level = empty, HI Level = full at setup.	None
E29	"E" Tube Low Level = empty, HI Level = full at setup.	None
E30	"F" Tube Low Level = empty, HI Level = full at setup.	None
E31	Barcode Reader error.	None
E32	The three sets of LEDs used to distinguish Coin size have been damaged.	None
E33	Recognition Ver Error	None

Code	Cause	LED
E35	Normal Mode Fished. Only for THB	None
E36	Security Mode Locked. Only for THB	None
E37	Security Mode Losted. Only for THB	None
E38	Coin Calibration fail. Only for THB	None
None	The "Inhibit" signal transmitted by the interface.	2 Red



International Currency Technologies Corporation

No.28, Ln. 15, Sec. 6, Minquan E. Rd., Neihu Dist., Taipei City 114, Taiwan

sales@ictgroup.com.tw (For Sales)

fae@ictgroup.com.tw (For Customer Service)

Website: www.ictgroup.com.tw

