



PROGRAMMER

FP-004

Operation Manual



International Currency Technologies Corp.

Use of Materials Limitations

International Currency Technologies Corporation (ICT) all rights reserved.

All materials contained are the copyrighted property of ICT.

All trademarks, service marks, and trade names are proprietary to ICT.

ICT reserves the right at all times to disclose or to modify any information as ICT deems necessary to satisfy any applicable law, regulation, legal process or governmental request, or to edit, refuse to post or to remove any information or materials, in whole or in part, in ICT's sole discretion.

Contents

1. Specification	2
2. Installation	
2-1. Harnesses Application.....	4
2-2. Direct Downloading	
PC to Device.....	17
2-3. Indirect Downloading	
PC to FP-004 to Device.....	23
2-4. Sensor Calibration.....	30
3. LED Status	31
Attachment Table 1	32
Attachment Table 2	33

1. Specification

Voltage : DC12V~24V

Current : 100mA

Power Consumption : 1.2W

Operating Temperature : 0°C~ 60°C

Storage Temperature : -20°C~70°C

Operating Humidity : 0% ~ 85% (RH)

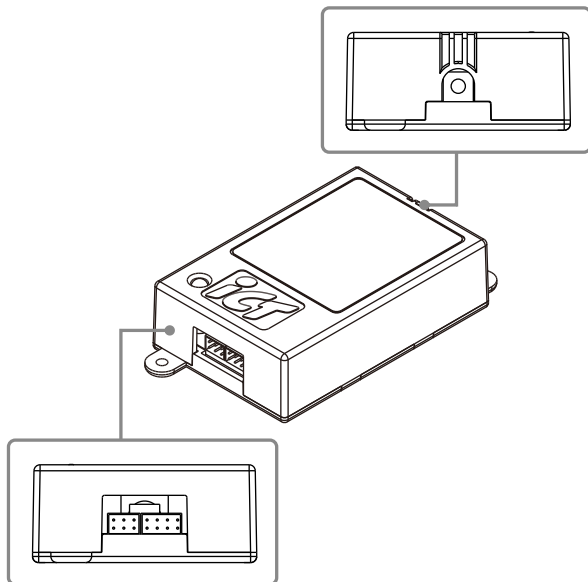

<Optional>

Transformer Specification : Model: CIL-R2014

Input: 100-240V, 50/60Hz, 0.5A

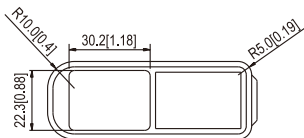
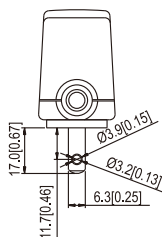
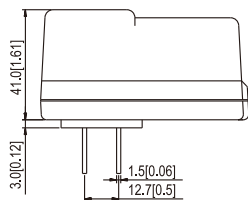
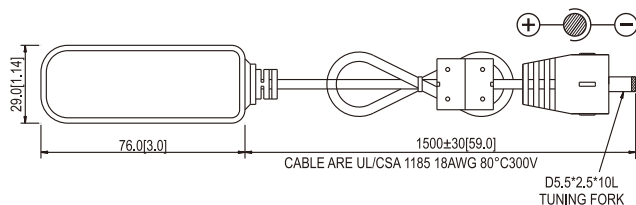

Unit: mm [inch]



The transformer is required in test mode.

2. Installation

2-1. Harnesses Application

Harnesses	Usage	Page
WEL-RF302	Power & Data Communication	9
WEL-RF303	Data Communication	10
Model <For BA>		
L70, L70T		
L77, L77T		
L83		
LX7		
S7A		
S7ER		
TAO-A, TAO-V		
TAO-AIIU, TAO-VIIU		
Model <For Non-BA>		
DC4		
Fortune(TP)		
FP-004		
UCA2, UCAES		

Harnesses	Usage	Page
WEL-RF401	Power & Data Communication	11
WEL-RF303	Data Communication	10
Model <For BA>		
A6, V6		
A7, V7		
BS7		
PA6		
PA7		
Model <For Non-BA>		
GP58		
RS232 to VCCS		
VMC15, VMC50		
NDE1000		

Harnesses	Usage	Page
WEL-RF402	Power & Data Communication	12
WEL-RCC42	Power & Data Communication	13
WEL-RF303	Data Communication	10
Model <For BA>		
BR2300		
BR1500		
E77		
E77-B		
NE77		
NE77-B2B		
NK682		
NK77		
NV68, NV72		
P70, P77, P85		

Harnesses	Usage	Page
WEL-RF402	Power & Data Communication	12
WEL-RCC42	Power & Data Communication	13
WEL-RF303	Data Communication	10
Model <For Non-BA>		
CC6100E, CC6100M, CC6100SA, CC6100V		
CSD, CVD, CVD2		
DCM5		
EX1000, EX3000		
MH		
MTB		
RFID CA TYPE		
SCA1, SCA2		





Harnesses	Usage	Page
WEL-RF403	Power & Data Communication	14
WEL-RF303	Data Communication	10
Model <For Non-BA>		
ND Series		

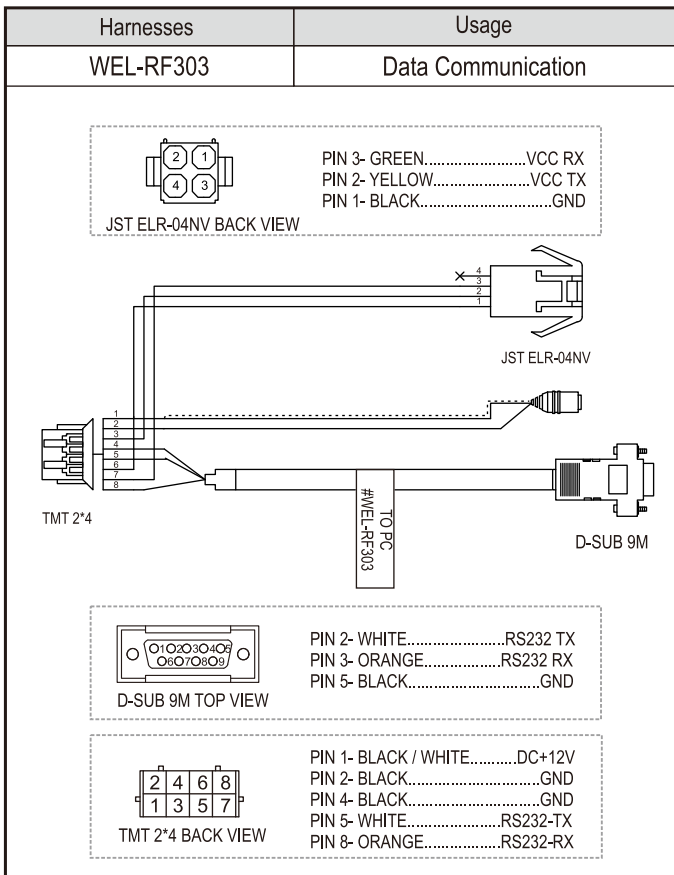

Harnesses	Usage	Page
3TM-RAA251-K1-02	Power & Data Communication	15
WEL-RF303	Data Communication	10
Model <For BA>		
TK77		

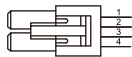

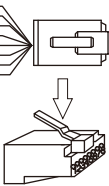
Harnesses	Usage	Page
WEL-RLV7719	Power & Data Communication	16
WEL-RF303	Data Communication	10
Model <For BA>		
LV77		

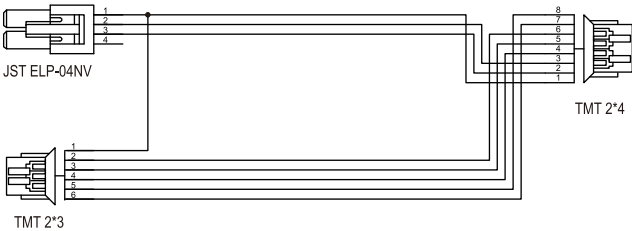

Harnesses	Usage		
WEL-RF302	Power & Data Communication		
<div data-bbox="512 378 937 560" style="border: 1px dashed black; padding: 5px; margin-bottom: 20px;"> <p>PIN 5- ORANGEE-PGC1-TO-BA PIN 4- REDE-PGD1-DATA PIN 3- BLACKGND PIN 2- YELLOWCVCC PIN 1- GREENE-RESET-BA</p> </div> <div data-bbox="108 626 927 873" style="text-align: center;"> <p>The diagram shows a central cable labeled "2464 22AWG 5C CABLE" with a vertical label "TO BILL ACCEPTOR #WEL-RF302". On the left, it connects to a "TMT 2*3" connector with pins 1-6. On the right, it connects to an "MH-B5" connector with pins 5-1.</p> </div> <div data-bbox="113 939 740 1128" style="border: 1px dashed black; padding: 5px; margin-top: 20px;"> <table border="0" style="width: 100%;"> <tr> <td style="text-align: center; vertical-align: middle;"> <p>TMT 2*3 BACK VIEW</p> </td> <td style="padding-left: 20px;"> <p>PIN 1 BLACK.....GND PIN 2 RED.....CVCC PIN 3 ORANGE.....E-RESET-BA PIN 5 YELLOW.....E-PGD1-DATA 5 PIN 6 GREEN.....E-PGC1-TO-BA</p> </td> </tr> </table> </div>		<p>TMT 2*3 BACK VIEW</p>	<p>PIN 1 BLACK.....GND PIN 2 RED.....CVCC PIN 3 ORANGE.....E-RESET-BA PIN 5 YELLOW.....E-PGD1-DATA 5 PIN 6 GREEN.....E-PGC1-TO-BA</p>
<p>TMT 2*3 BACK VIEW</p>	<p>PIN 1 BLACK.....GND PIN 2 RED.....CVCC PIN 3 ORANGE.....E-RESET-BA PIN 5 YELLOW.....E-PGD1-DATA 5 PIN 6 GREEN.....E-PGC1-TO-BA</p>		

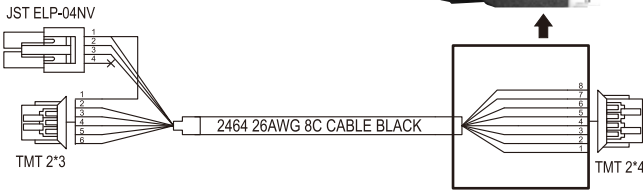

Harnesses	Usage
WEL-RF401	Power & Data Communication
<div style="display: flex; justify-content: space-between; align-items: flex-start;"> <div style="border: 1px dashed gray; padding: 10px; width: 30%;">  <p>JST ELP-04NV BACK VIEW</p> </div> <div style="width: 65%;"> <p>PIN 1- GRAY.....GND PIN 2- BLACK.....3.3V RX PIN 3- ORANGE.....3.3V TX</p> </div> </div> <div style="display: flex; justify-content: space-around; align-items: center;"> <div style="text-align: center;">  <p>JST ELP-04NV</p> </div> <div style="text-align: center;">  <p>TMT 2*3</p> </div> <div style="text-align: center;">  <p>PCB JACK VIEW</p> </div> </div> <div style="display: flex; justify-content: space-between;"> <div style="border: 1px dashed gray; padding: 10px; width: 45%;">  <p>TMT 2*3 BACK VIEW</p> <p>PIN 1- GRAY.....GND PIN 2- YELLOW.....VCC</p> </div> <div style="border: 1px dashed gray; padding: 10px; width: 45%;"> <p>PIN 8- BROWN.....RX1 PIN 7- BLUE.....TX1 PIN 6- YELLOW.....VCC PIN 5- GREEN.....RESET PIN 4- RED.....PROGRAM PIN 3- BLACK.....RX2 PIN 2- ORANGE.....TX2 PIN 1- GRAY.....GND</p> </div> </div>	

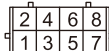
Harnesses	Usage
WEL-RF402	Power & Data Communication
<div data-bbox="111 321 660 467" style="border: 1px dashed gray; padding: 5px; margin-bottom: 20px;">  <p>JST ELP-04NV BACK VIEW</p> <p>PIN 1- BLACK.....GND PIN 2- YELLOW.....RX2 PIN 3- GREEN.....TX2</p> </div> <div data-bbox="106 499 930 797" style="margin-bottom: 20px;">  <p>JST ELP-04NV</p> <p>TMT 2*3</p> <p>TMT 2*4</p> </div> <div data-bbox="103 841 498 1239" style="border: 1px dashed gray; padding: 5px; display: inline-block; width: 48%; vertical-align: top;">  <p>TMT 2*3 BACK VIEW</p> <p>PIN 1- BLACK.....GND PIN 2- RED.....VCC PIN 3- GRAY.....RESET PIN 4- ORANGE.....PROGRAM PIN 5- BROWN.....RX1 PIN 6- BLUE.....TX1</p> </div> <div data-bbox="533 841 928 1239" style="border: 1px dashed gray; padding: 5px; display: inline-block; width: 48%; vertical-align: top;">  <p>TMT 2*4 BACK VIEW</p> <p>PIN 1- BLACK.....GND PIN 2- GREEN.....TX2 PIN 3- YELLOW.....RX2 PIN 4- ORANGE.....PROGRAM PIN 5- GRAY.....RESET PIN 6- RED.....VCC PIN 7- BLUE.....TX1 PIN 8- BROWN.....RX1</p> </div>	

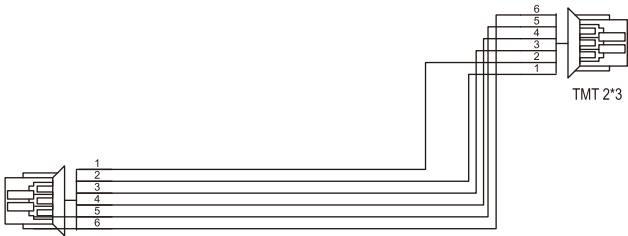
Harnesses	Usage
WEL-RCC42	Power & Data Communication
<div data-bbox="98 346 644 492" style="border: 1px dashed gray; padding: 5px; margin-bottom: 20px;">  <p>JST ELP-04NV BACK VIEW</p> <p>PIN 1- BLACK.....GND PIN 2- YELLOW.....RX2 PIN 3- GREEN.....TX2</p> </div> <div data-bbox="98 575 937 822" style="margin-bottom: 20px;">  <p>JST ELP-04NV</p> <p>TMT 2*3</p> <p>2464 26AWG 8C CABLE BLACK</p> <p>TMT 2*4</p> </div> <div data-bbox="103 851 502 1252" style="border: 1px dashed gray; padding: 5px; margin-bottom: 20px;">  <p>TMT 2*3 BACK VIEW</p> <p>PIN 1- BLACK.....GND PIN 2- RED.....VCC PIN 3- GRAY.....RESET PIN 4- ORANGE.....PROGRAM PIN 5- BROWN.....RX1 PIN 6- BLUE.....TX1</p> </div> <div data-bbox="533 851 932 1252" style="border: 1px dashed gray; padding: 5px;">  <p>TMT 2*4 BACK VIEW</p> <p>PIN 1- BLACK.....GND PIN 2- GREEN.....TX2 PIN 3- YELLOW.....RX2 PIN 4- ORANGE.....PROGRAM PIN 5- GRAY.....RESET PIN 6- RED.....VCC PIN 7- BLUE.....TX1 PIN 8- BROWN.....RX1</p> </div>	

Harnesses	Usage																								
WEL-RF403	Power & Data Communication																								
<div style="text-align: center; border: 1px dashed gray; padding: 10px; margin: 10px auto; width: fit-content;">  <p>TMT 2*3 BACK VIEW</p> <table style="margin-left: auto; margin-right: auto;"> <tr><td>PIN 1- RED.....</td><td>VCC</td></tr> <tr><td>PIN 2- BLACK.....</td><td>GND</td></tr> <tr><td>PIN 3- BROWN.....</td><td>RESET</td></tr> <tr><td>PIN 4- YELLOW.....</td><td>PROGRAM</td></tr> <tr><td>PIN 5- GREEN.....</td><td>.RX1</td></tr> <tr><td>PIN 6- BLUE.....</td><td>TX1</td></tr> </table> </div>  <div style="text-align: center; border: 1px dashed gray; padding: 10px; margin: 10px auto; width: fit-content;">  <p>TMT 2*3 BACK VIEW</p> <table style="margin-left: auto; margin-right: auto;"> <tr><td>PIN 1- BLACK.....</td><td>GND</td></tr> <tr><td>PIN 2- RED.....</td><td>VCC</td></tr> <tr><td>PIN 3- BROWN.....</td><td>RESET</td></tr> <tr><td>PIN 4- YELLOW.....</td><td>PROGRAM</td></tr> <tr><td>PIN 5- GREEN.....</td><td>.RX1</td></tr> <tr><td>PIN 6- BLUE.....</td><td>TX1</td></tr> </table> </div>		PIN 1- RED.....	VCC	PIN 2- BLACK.....	GND	PIN 3- BROWN.....	RESET	PIN 4- YELLOW.....	PROGRAM	PIN 5- GREEN.....	.RX1	PIN 6- BLUE.....	TX1	PIN 1- BLACK.....	GND	PIN 2- RED.....	VCC	PIN 3- BROWN.....	RESET	PIN 4- YELLOW.....	PROGRAM	PIN 5- GREEN.....	.RX1	PIN 6- BLUE.....	TX1
PIN 1- RED.....	VCC																								
PIN 2- BLACK.....	GND																								
PIN 3- BROWN.....	RESET																								
PIN 4- YELLOW.....	PROGRAM																								
PIN 5- GREEN.....	.RX1																								
PIN 6- BLUE.....	TX1																								
PIN 1- BLACK.....	GND																								
PIN 2- RED.....	VCC																								
PIN 3- BROWN.....	RESET																								
PIN 4- YELLOW.....	PROGRAM																								
PIN 5- GREEN.....	.RX1																								
PIN 6- BLUE.....	TX1																								

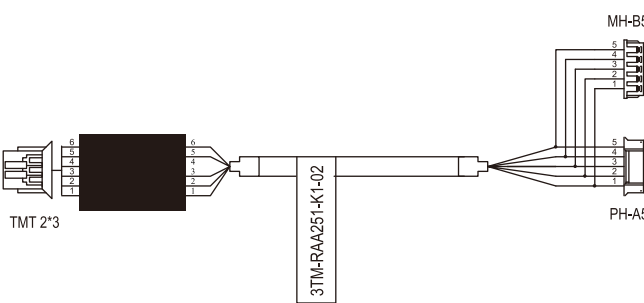
Harnesses	Usage																						
3TM-RAA251-K1-02	Power & Data Communication																						
 <p>The diagram illustrates the 3TM-RAA251-K1-02 harness. It features a central cable labeled '3TM-RAA251-K1-02'. On the left, it connects to a 'TMT 2*3' connector with pins 1 through 6. On the right, it branches into two connectors: 'MH-B5' and 'PH-A5', both with pins 1 through 5. The wiring is as follows: TMT Pin 6 to MH-B5 Pin 5; TMT Pin 5 to MH-B5 Pin 4; TMT Pin 4 to MH-B5 Pin 3; TMT Pin 3 to MH-B5 Pin 2; TMT Pin 2 to MH-B5 Pin 1; TMT Pin 1 to PH-A5 Pin 5; TMT Pin 6 to PH-A5 Pin 4; TMT Pin 5 to PH-A5 Pin 3; TMT Pin 4 to PH-A5 Pin 2; TMT Pin 3 to PH-A5 Pin 1.</p> <table border="1" data-bbox="108 1026 492 1244"> <tr> <td>PIN 6- GREEN.....</td> <td>RXD</td> </tr> <tr> <td>PIN 5- YELLOW.....</td> <td>TXD</td> </tr> <tr> <td>PIN 4- BLUE.....</td> <td>PROGRAM</td> </tr> <tr> <td>PIN 3- ORANGE.....</td> <td>RESET</td> </tr> <tr> <td>PIN 2- RED.....</td> <td>VCC</td> </tr> <tr> <td>PIN 1- BLACK.....</td> <td>GND</td> </tr> </table> <table border="1" data-bbox="554 1026 911 1244"> <tr> <td>PIN 5- ORANGE</td> <td>RESET</td> </tr> <tr> <td>PIN 4- RED</td> <td>VCC</td> </tr> <tr> <td>PIN 3- BLACK</td> <td>GND</td> </tr> <tr> <td>PIN 2- YELLOW.....</td> <td>PGD</td> </tr> <tr> <td>PIN 1-GREEN</td> <td>PGC</td> </tr> </table>		PIN 6- GREEN.....	RXD	PIN 5- YELLOW.....	TXD	PIN 4- BLUE.....	PROGRAM	PIN 3- ORANGE.....	RESET	PIN 2- RED.....	VCC	PIN 1- BLACK.....	GND	PIN 5- ORANGE	RESET	PIN 4- RED	VCC	PIN 3- BLACK	GND	PIN 2- YELLOW.....	PGD	PIN 1-GREEN	PGC
PIN 6- GREEN.....	RXD																						
PIN 5- YELLOW.....	TXD																						
PIN 4- BLUE.....	PROGRAM																						
PIN 3- ORANGE.....	RESET																						
PIN 2- RED.....	VCC																						
PIN 1- BLACK.....	GND																						
PIN 5- ORANGE	RESET																						
PIN 4- RED	VCC																						
PIN 3- BLACK	GND																						
PIN 2- YELLOW.....	PGD																						
PIN 1-GREEN	PGC																						

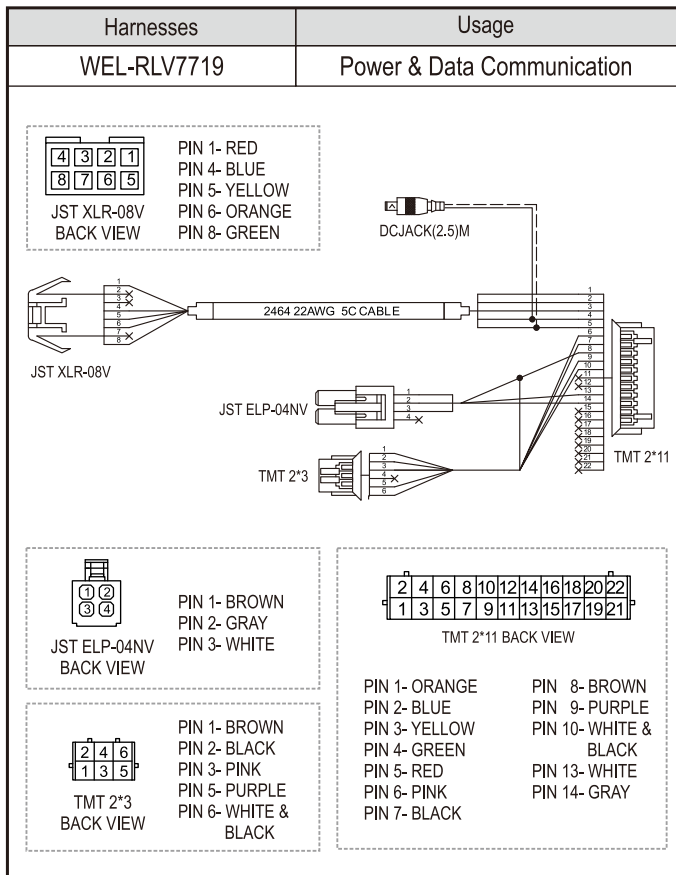

2-2. Direct Downloading

< PC ⇄ Device >

Step 1. Connection

Harnesses: WEL-RF302 / WEL-RF303

For BA / For Non-BA (refer to page 4)

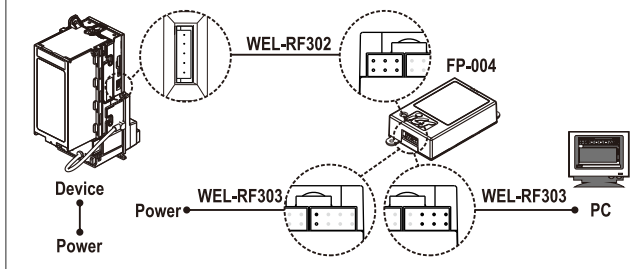

Harnesses: WEL-RF401 / WEL-RF303

For BA / For Non-BA (refer to page 5)

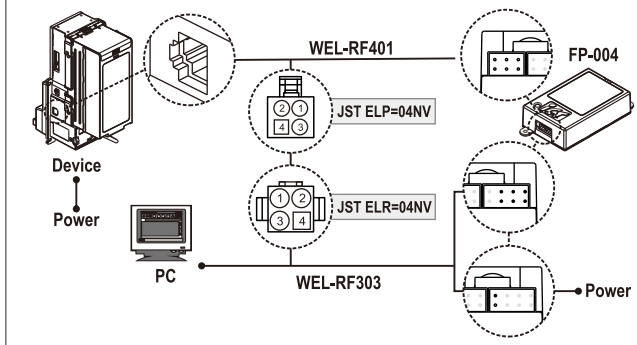

< PC ⇄ Device >

Harnesses: WEL-RF402 / WEL-RCC42 / WEL-RF303

For BA (refer to page 6) / For Non-BA (refer to page 7)

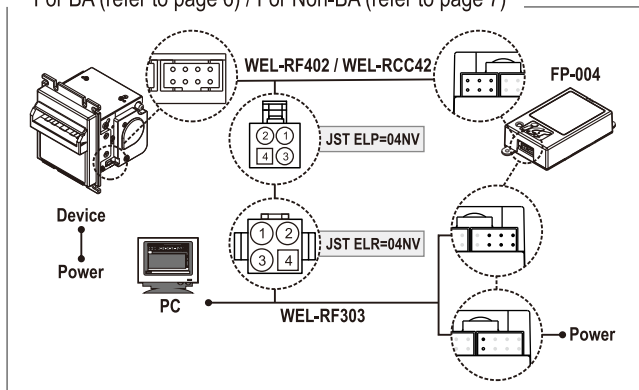

Harnesses: WEL-RF402 / WEL-RCC42 / WEL-RF303

For Non-BA (refer to page 7)

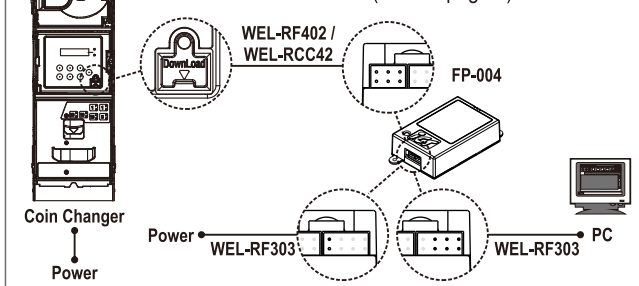

< PC ⇄ Device >

Harnesses: WEL-RF403 / WEL-RF303

For Non-BA (refer to page 8)

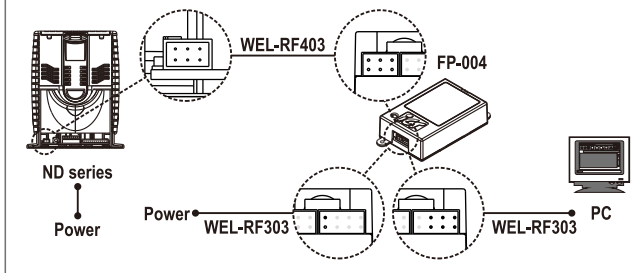
**Harnesses: 3TM-RAA251-K1-02 / WEL-RF303**

For BA (refer to page 8)

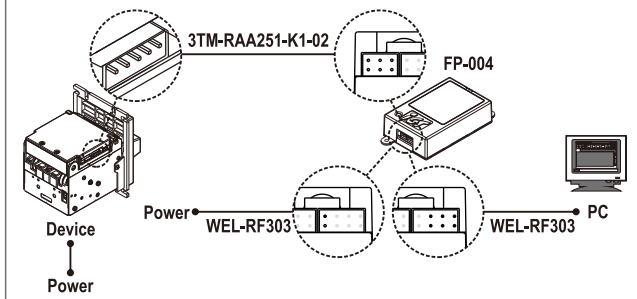

< PC ⇔ Device >

Harnesses: WEL-RLV7719 / WEL-RF303

For BA (refer to page 8)

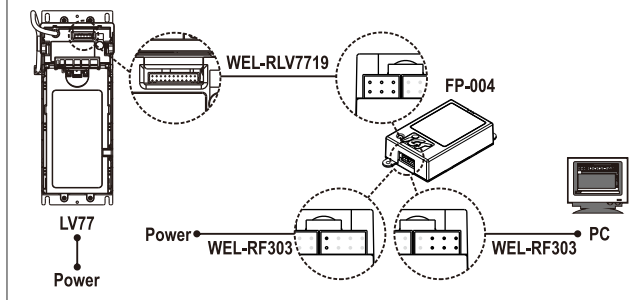

1. Power must be applied to device after connection.
2. Please refer to BA or Non-BA installation Guides for precise connector locations.

< PC ⇨ Device >

Step 2.

Launch software FP-004.

Download FP-004 from <http://www.ictgroup.com.tw/> ⇨ support

Step 3.

Use notepad to edit file “FP-004x.INI”. The com port setting varies according to the connection on PC.

```
[COM PORT SETTING]
PORT=COM1
BAUD=115200
DATA=8
STOP=1
PARITY=E
```

Step 4.

Select the appropriate model under **bill acceptor** type.

Retrieve the firmware path.

(Drag the firmware (hex file) into FP-004 window.)

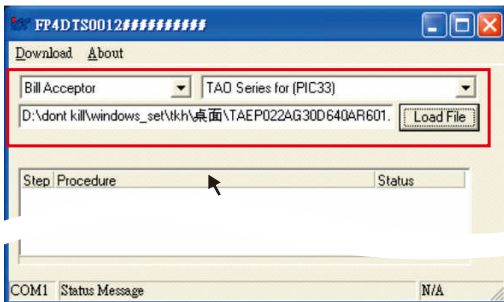

< PC ⇨ Device >

Step 5.

Download firmware to target through FP-004.

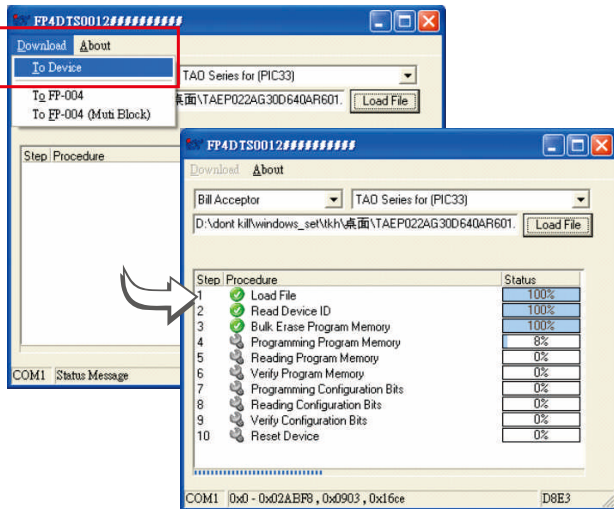

Step 6.

Complete downloading.

Firmware is saved in FP-004 now.

2-3. Indirect Downloading

< PC ⇄ FP-004 ⇄ Device >

Step 1.
Connection

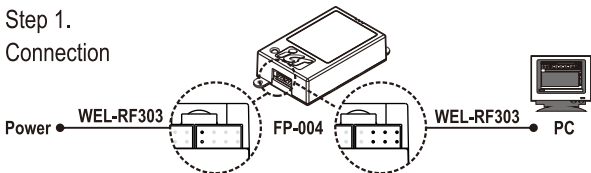

Power must be applied to FP-004 after connection.

Step 2.

Execute FP-004 download tool “FP4DT-exe”.

Step 3.

Use notepad to edit file “FP-004x.INI”.
The com port setting varies according
to the connection on PC.

```
[COM PORT SETTING]
PORT=COM1
BAUD=115200
DATA=8
STOP=1
PARITY=E
```

Step 4.

Select the appropriate model under **bill acceptor** type.

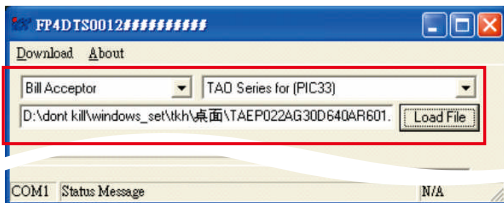

< PC ⇄ FP-004 ⇄ Device >

Step 5.

Choose “Download” and “To FP-004” to proceed program burning.

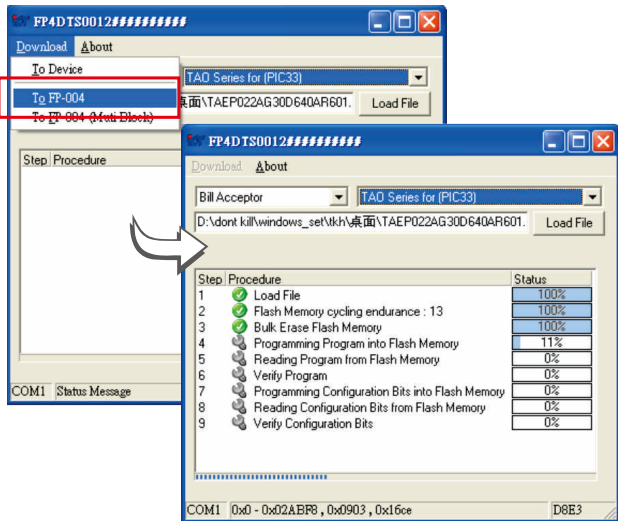

Step 6.

Complete downloading.

Firmware is saved in FP-004 now.

< PC ==> FP-004 ==> Device >

Step 1. Connection

Harnesses: WEL-RF302

For BA / For Non-BA (refer to page 4)

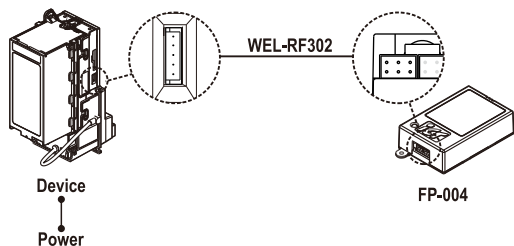

Harnesses: WEL-RF401

For BA / For Non-BA (refer to page 5)

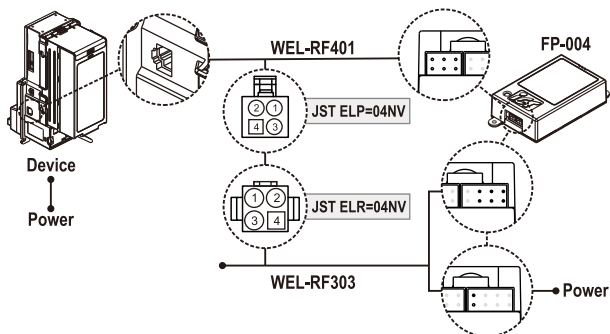

< PC ⇨ FP-004 ⇨ Device >

Harnesses: WEL-RF402 / WEL-RCC42

For BA (refer to page 6) / For Non-BA (refer to page 7)

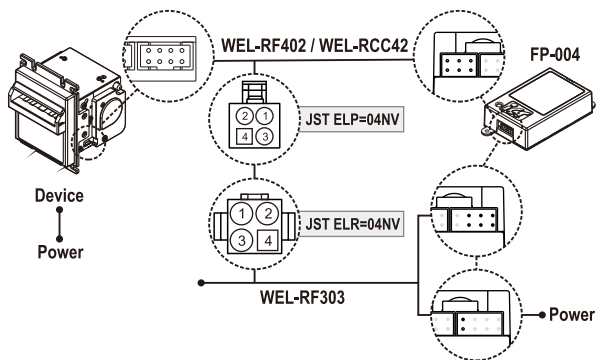

Harnesses: WEL-RF402 / WEL-RCC42

For Non-BA (refer to page 7)

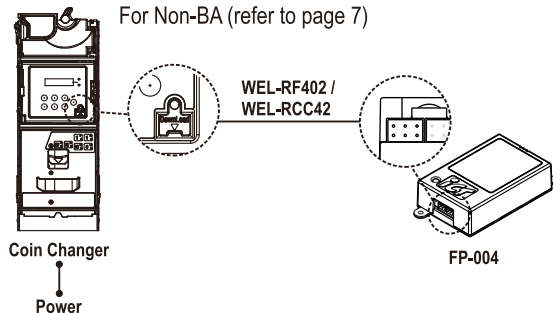

< PC \Rightarrow FP-004 \Rightarrow Device >**Harnesses: WEL-RF403**

For Non-BA (refer to page 8)

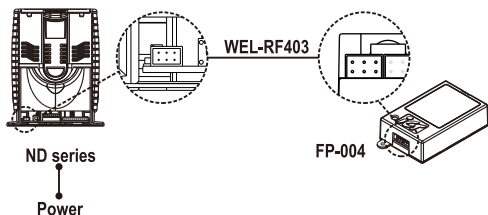
**Harnesses: 3TM-RAA251-K1-02**

For BA (refer to page 8)

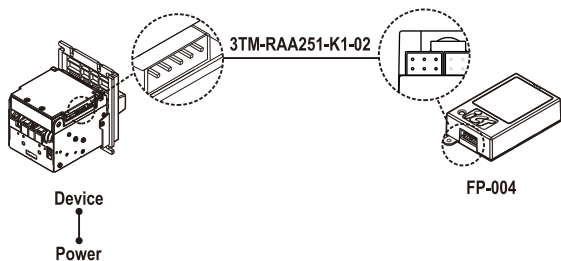

< PC ⇄ FP-004 ⇄ Device >

Harnesses: WEL-RLV7719

For BA (refer to page 8)

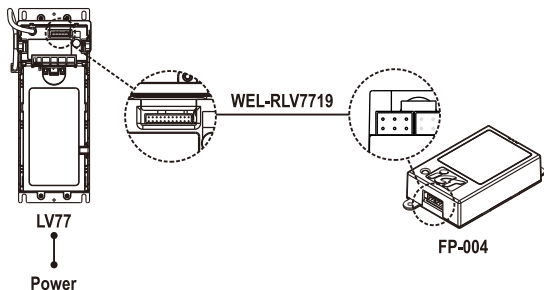

1. Power must be applied to device after connection.
2. Please refer to BA or Non-BA installation Guides for precise connector locations.

< PC ⇄ FP-004 ⇄ Device >

Step 2.

Start downloading a new firmware to Device.

- 2-1. Press and hold the button for at least 3 seconds, and wait until the faceplate LED turns to purple.
- 2-2. The faceplate LED will flash faster and faster as it's approaching the end of download progress.
- 2-3. After downloading, the faceplate LED will indicate "Green" as successful downloading or "Red" as failed downloading in 3 seconds.

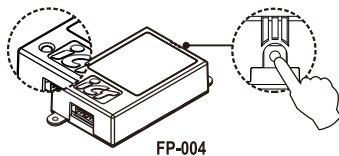

Note:

As downloading the firmware to Device in this mode, PC Tool shows the download progress automatically.

Step 3.

Complete indirect downloading.

2-4. Sensor Calibration

Calibrate sensor of the Bill Acceptor with calibration card every time after download can keep high recognition rate. In addition to the regular bill acceptor calibration by connecting to PC, there is another option allows users to calibrate Bill Acceptor after indirect downloading without PC.

Please follow the steps below to calibrate BA:

Step 1.

After download complete, FP-004 would be back to standby mode, and BA will be in white card calibration mode automatically (LED constantly stays green).

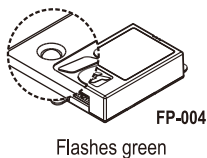
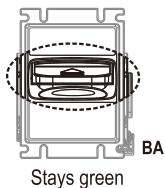

Step 2.

Insert white card in BA to calibrate.

Step 3.

White card will be rejected when calibrating succeed.

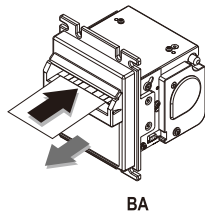

Step 4.

Restart BA after calibrating

3. LED Status

Flashes		Mode	Status
GREEN	Flashing	Idling	FP-004 to Device Mode
	ON	Download	Download Successful
BLUE	ON	Idling	PC to BA RS232 Mode
YELLOW	ON	Idling	PC to BA Test Mode
RED	Flashing	Idling	Memory Problem
	ON	Download	Download Fail
PURPLE	ON	Download	Busy
	Flashing		Download in Progress

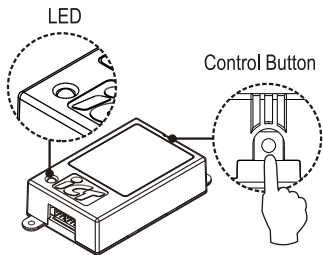

Step 1.
Click to switch between PC and Device.

Step 2.
Press and hold three seconds to start downloading from FP-004 to Device.

Attachment Table 1

BA Model Type	Models
A / V Series for (549)	A6, A7, V6, V7, PA6, PA7
V Series for (PIC33)	V7E, V77E, BS7, LX7
E Series for (549)	E77
L Series for (PIC33)	L70, L70T, L77, L77T, L83
N Series for (549)	N6, N7
NK Series for (487)	NK682, NK77
P Series for (549)	P70, P77, P85
S Series for (PIC33)	S7A, S7ER
TAO Series for (PIC33)	TAO-A, TAO-AIIU, TAO-V, TAO-VIIU
NV Series for (STM32)	NV68, NV72
LV77 for (PIC33)	LV77
Bill Recycle Series	BR2300, BR1500, E77 B2B, NE77, NE77 B2B,
Coin Changer Series	CC6000, CC6100
Coin Dispenser for (STM8S207)	Coin Dispenser
Coin Dispenser for (626)	CSD, CVD, CVD2
ID Verifier Series	DC4, DCM5
Money Changer Series	EX1000, EX3000
Ticket Printer for (PIC32)	FORTUNE
Note Dispenser Series	ND Series
RS232 to VCCS Converter Board (487)	RS232 to VCCS Converter Board

Attachment Table 2

BA Model Type	Models
RFID Series	RFID CA type
SCA Series	SCA1, SCA2
UCA Series	UCA2, UCAES
TK77 Series	TK77
Vending Machine	VMC15, VMC50



Please contact ICT for any other questions.



International Currency Technologies Corporation

No.28, Ln. 15, Sec. 6, Minquan E. Rd., Neihu Dist., Taipei City 114, Taiwan

sales@ictgroup.com.tw (For Sales)

fae@ictgroup.com.tw (For Customer Service)

Website: www.ictgroup.com.tw

